

Experimental Investigation of Porous Bearings Under Different Lubricant and Lubricating Conditions

Ertuğrul DURAK*

Suleyman Demirel University, Mechanical Engineering Dept., 32260, Isparta, Turkey

The performance of porous bearing under different lubricants and lubricating conditions was experimentally investigated in this study. In order to carry out the experiments, a new test rig was designed to determine the tribological properties of based sintered bronze journal bearings that were manufactured by powder metallurgy (P/M) techniques. To determine the effects of lubricating conditions with and without oil supplement (OS) on the tribological characteristics of these bearings under static loading and periodic loadings, some experiments were carried out using different lubricants. In the tests, pure base oil (SAE 20W50), two fully formulated commercial engine oils (SAE20W50) and lubricating oils with commercial additive concentration ratio of 3% were used. The worn surfaces of test bearings were examined using optical microscopy. Experimental results showed that the change in friction coefficient was more stable and in smaller magnitude under static loading than that of periodic loading. In addition, the friction coefficient and the wear rate conducted with base oil resulted in higher values than those of fully formulated oils with and without OS lubricating conditions. The experimental results obtained in this study indicated that the correct selection of lubricant and suitable running conditions were very important on the tribological characteristics of porous bearings.

Key Words : Powder Metallurgy, Journal Bearings, Static and Periodic Loading, Friction Coefficient, Wear, With-Without Oil Supplement Lubricating Conditions

1. Introduction

Oil-impregnated porous bearing is known as the self-lubricating bearing or oilless bearing or no-oil feed bearing. Such bearings might be provided for service that is virtually maintenance-free (Kasahara, 1997). Oil-impregnated porous bearings are manufactured by powder metallurgy (P/M) techniques and they are often used in places where there is no accessibility for periodic lubrication. The cost of the bearings is also low. They are widely used in instruments, computers, office equipment, domestic equipment, electric

motors, automobiles, sewing, agricultural, printing, and packaging machines. The bearings operate under hydrodynamic lubrication conditions in the initial stages of their life when the pores are almost full of oil. However, they operate under mixed or boundary lubrication conditions during starting and stopping and when the oil in the pores has been lost after a certain period of usage due to oil leakage and evaporation (Raman, 1998). During service operation of a porous oil bearing, oil will come out from the pores to lubricate the friction surface (self-lubricating) and, upon shut-down of the operation, oil will penetrate back to the pores. As such, the lubrication of porous oil bearing is efficiently realized with comparatively small amount of oil (Kaneko, 1993).

Nowadays, there are many experimental studies about porous bearings under static loading, but there are less experimental investigations under

* E-mail : edurak@mmf.sdu.edu.tr
TEL : +90-246-2111254; FAX : +90-246-2370428
Suleyman Demirel University, Mechanical Engineering Dept., 32260, Isparta, Turkey. (Manuscript Received October 28, 2002; Revised June 17, 2003)

dynamic loading which occurs in real operating conditions (Kasahara, 1997 ; Raman, 1998 ; Kaneko, 1993 ; Cusano and Phelan, 1973 ; Braun, 1982 ; Junghans et al., 1996 ; Yong-Xin et al., 1985). From this respect, a new test rig was designed to determine the tribological properties of porous bearings. The purpose of this study is to investigate the friction and wear behavior of porous bearings with and without OS under both static and periodic loading conditions. Test bearings were manufactured by powder metallurgy (P/M) method. Experiments were carried out using different lubricants and lubricating conditions. It is expected that this study may be useful to the application of P/M based bearings in practice.

2. Experimental Procedures

2.1 Materials

The material of the test shaft was SAE 1050 hardened steel (55 Rockwell). The surface of journal was prepared by cylindrical grinding and had N4 surface finish quality and its average surface roughness (Ra) was 0.305 μm . The test journal bearing had N4 surface finish quality with an average surface roughness (Ra) of 0.905 μm . Commercial P/M based sintered bronze bearings were used in the tests and they contained elemental copper and tin powders. Composition of powders was 90% Cu+10% Sn. The test bearing material was sintered bronze with a density of 80%. These bearings are nowadays used mostly for automobile components. The test bearings were impregnated with base oil and two

commercial engine oils (SAE 20W50) and lubricating oil with commercial additive concentration ratio of 3%. The same three lubricants and additive were used in the tests with OS. The properties of journal, bearing and experimental conditions are summarized in Table 1. In addition, the physical properties of the test lubricants and additive are given in Table 2. The commercial names of the lubricants are withheld for the reason of confidentiality. Figure 1 shows a view of the test bearing, and optical microscopy of the test bearing surface.

2.2 The test rig

A new test rig was designed to measure the friction force in the porous bearing under various conditions such as static loading and dynamic loading, especially with vertical periodic loads.

Table 1 Experiment parameters

Inside diameter of test bearing	12.013 mm
Outside diameter of test bearing	15 mm
Diameter of test journal	12 mm
Width of test bearing	12 mm
Density (g/cc)	7
Relative bearing clearance	% 0.108
Porosity (mean)	% 20
Oil content	~ % 13
Lubricant-feed pressure (bar), (for with oil supplement tests)	1.0
Rotational speed of test journal (rpm)	1500
Velocity (m/s)	0.94
Environmental temperatures (°C)	25±2

Table 2 Physical properties of the test lubricants and additive

Properties	Values			
	Base oil	Lubricant 1	Lubricant 2	Additive
Density (15°C, g/cc)	0.886	0.892	0.891	1.05
Flash point (°C)	260	190	218	163
Kinematic viscosity (cSt at 40°C-100°C)	179.8-19.37	163.2-19.2	161-18.1	70-9
Dynamic viscosity (Pa.s at 25°C)	0.419	0.351	0.365	-
Viscosity index	123	125	120	102
Pour Point (°C)	~ -10	-15	-24	-27

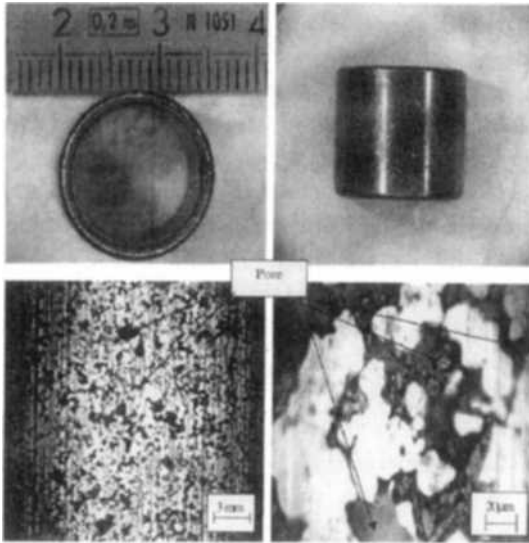
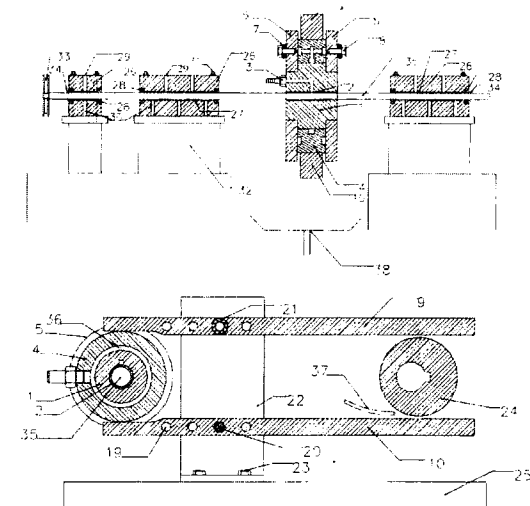

Fig. 1 Views of test bearing and optical microscopy of the bearing test surface



- | | |
|--|--|
| 1-Bearing Housing | 2-Test P/M bearing |
| 3-Oil supplier of test bearing | 4-Cylindrical part with squeeze oil film |
| 5-Measurement plate | 6-Oil supplier of squeeze oil film |
| 7-Rod end | 8-Bolt (M8.8) |
| 9-Lever of top loading | 10-Lever of bottom loading |
| 19-Adjustment holes of loading levers | |
| 20-Support pin of lever | 21-Rolling bearings |
| 22-Support plates of loading levers | |
| 23-Bolts (M10) | 24-Eccentric disc of loading |
| 25-Main body | 26-Plates of support bearing |
| 27-Support bearing | 28-O-ring |
| 29, 30-Entry and exit of oil supplier of support bearing | |
| 31-Bolt (M8.8) | 32-Plates pad of support bearing |
| 33-V-belt pulley | 34-Ring |
| 35-Journal of test | 36-Oil channel of squeeze oil film |
| 37-Lubricating connection of loading eccentric disc | |
| 38-Collector of lubricant | |

Fig. 2 Cross sections of the test rig

The test rig was fabricated at the Mechanical Engineering Laboratory of Suleyman Demirel University (Durak et al., 2002; Kurbanoglu et al., 2002). The test rig is schematically shown in Figure 2, and views of the test rig are shown in Figure 3. It consists of a 1.5 kW, 3000 rpm D. C. motor driving the test journal (35) through a V-belt pulley (33). The test speed can be adjusted by the V-belt pulley with different dimensions. The test porous bearing (2) was fitted in the housing (1) with a very light press fit using a specially designed fixture.

An eccentric disc (24) and lever (9) apply vertical periodic loads to the test porous bearing (2). The eccentric disc (24) is driven by an A. C. motor (1.1 kW, 1500 rpm). The frictional torque between the journal (35) and the test bearing (2) had to be measured independently of the other torques (Cusano and Phelan, 1973). To make this possible, the load was transmitted vertically down through the squeeze oil film that was formed between the journal bearing housing (1) and the loading circle (9). The lubricant was supplied by a gear pump in order to form the squeeze film mentioned above. During the test, any metallic contacts occurring between the journal bearing housing (1) and the loading circle (9) were measured by an electrical method. Metallic contact is very important from the viewpoint of accuracy of the test rig measurement. The lubrication systems for oil supply to squeeze film, for the bearing support, and for the tests with OS were mounted on a separate table to avoid the transmission of vibration of the motor, pump, etc. to the base plate.

When the test journal (35) is rotated, the friction torque on the bearing will try to rotate

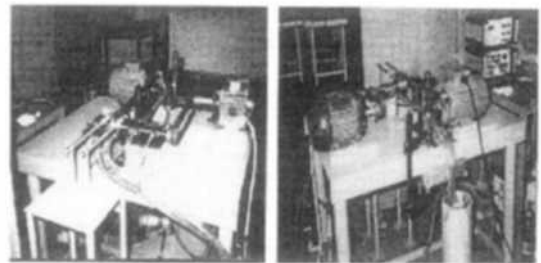

Fig. 3 View of the test rig

the bearing housing (1). Figure 4 shows the detail of the test rig for measuring the frictional torque. The friction transducer measures the reaction force generated due to the torque. The friction transducer consists of strain gauges (15) in a Wheatstone bridge configuration. The force and the coefficient of friction were recorded simultaneously with respect to time using a computer-based data acquisition system.

2.3 Experimental procedure

Figure 5 shows the selected load patterns for the experiments. The test bearing was initially subjected to a running in process. A few drops of the same oils as impregnated in the test bearing were placed on the journal surface to enable flushing out of wear debris in the tests without

OS lubricating condition. Before beginning the experiments, the test bearings were run for five minutes in order to make the surfaces smoother and to flush out the wear debris during the running-in process under low speed and low loading conditions.

In this study, base oil, two fully formulated commercial crankcase mineral oils (SAE 20W50) and commercial oil additive (3%) added into those oils were tested to determine the tribological properties such as friction coefficient and wear for both with and without OS lubricating conditions. The tests without OS were carried out without any further addition of oil. The oil stored in the porous bearing alone was used for lubrication during the test under periodic loading because it represents the actual working condition for porous bearings. In this study, tests were carried out under both static and periodic loadings as shown in Figure 5. Before starting the tests with OS, 3 liters of lubricant was circulated through the filter and filled up the oil storage. Lubricant was supplied at 1 bar and 0.2 liter/hour through a single 3 mm diameter hole located in the part of the unloaded of the test bearing for the tests with OS.

In the tests without OS, base oil (SAE 20W50), two fully formulated commercial engine mineral oils (SAE 20W50), and commercial oil additive (3%) added into those oils were impregnated to the test bearings for 12 hours. Tests were carried out under room temperature (25°C) at 1500 rpm. The tests were carried out until the sliding distance reached 3 km. Every 5 seconds, the friction force was measured and recorded by the computer. All the tests were repeated three times and then the average data were taken into account to plot the results. All the bearing specimens were cleaned with hexane and then dried before the impregnation process and after the tests to determine of wear amount.

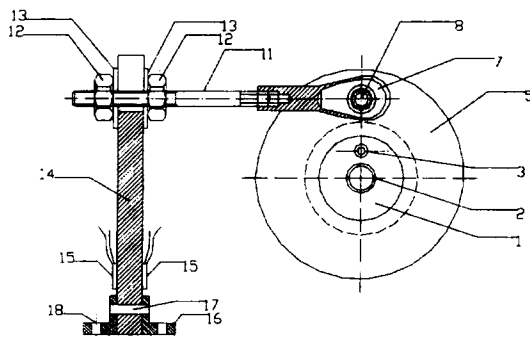

- 1-Bearing Housing
- 2-Test P/M bearing
- 3-Oil supplier of test bearing
- 5-Measurement plate
- 7-Rod end
- 8-Bolt (M8.8)
- 11-Lever of pull
- 12-Nut
- 13-Washing
- 14-Bar of Aluminum
- 15-strain-gauges
- 16-Frame
- 17, 18-Bolts (M10)

Fig. 4 Drawing detail of measuring of frictional torque in the test bearing

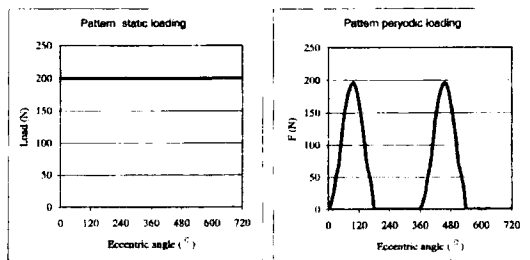

Fig. 5 Test load patterns

3. Results and Discussions

Lubrication performance characteristics (load capacity, the friction coefficient, wear, bearing temperature, etc.) of porous oil bearings were

reported by several researchers. However, a direct comparison of the data among available reports was not always of much significance due to lack of normalization of the operation conditions, bearing parameters and quality of impregnated oil. Thus, no systematic understanding for performance characteristics of porous oil bearing could be gained through analysis of available experimental data. Actually, the mode of lubrication realized in porous oil bearings scatters widely ranging from hydrodynamic lubrication to mixed lubrication and boundary lubrication. Further more, there are additional factors that influence the lubrication performance of porous oil bearing (oil content in bearing pores, permeability of the porous bearing body, porosity of the bearing body, chemical and physical properties of impregnated oil, etc.) than those of common solid (sliding) bearing (Kaneko, 1993).

Surface pressure of 1 MPa and sliding velocity of 100 m/minute are the standard service conditions of oil-containing sintered metallic bearing. In the range of surface pressure higher than 1 MPa and sliding velocity lower than 100 m/minute, lubrication layer over the porous sliding surface would become unstable. In the range of sliding velocity appreciably higher than 100 m/minute, undesired consumption of lubricant due to frictional heat and instability of friction coefficient might be caused because of the inherently imperfect nature of the fluid lubrication in this type of bearing. In any event, manufacturers of self-lubricating bearings invested their efforts to develop advanced materials to cope with service conditions severer than the standard ones

(Kasahara, 1997). Cusano and Phelan (Cusano and Phelan, 1973; Raman, 1998) conducted experiments simulating the practical conditions by not supplying additional oil and found that oil stored inside the bearing alone was not sufficient to provide hydrodynamic lubrication conditions when PV values were as high as 105 MPa·m/minute; In these condition bearings could work only under boundary lubrication. However, at lower PV values in the order of 69 MPa·m/minute they found that bearings could work in hydrodynamic condition. Also, the limiting values of PV for porous bearing in boundary lubrication condition were given as 110 MPa·m/minute (for speed 45-60 m/minute) (Cusano, 1997). PV value for the tests without OS in this study was calculated as 78 MPa·m/minute (speed is 56 m/minute). Thus, tests without OS were carried out in the boundary lubrication regime. Also, it was clearly seen that the PV value used in this study fall in the permissible range.

Figures 6-8 show the coefficient of friction as a function of time for all lubricants under periodic loading condition. Also, Figures 9-11 show the friction coefficient versus duration of test for all lubricants under static loading condition. Average values of friction coefficient for the tests are given in Table 3.

From curves in the figures (Figures 6-11) it is seen that the characteristic of friction coefficient is similar for the same lubricating conditions. In the tests without OS, it is noted that the coefficient of friction is relatively higher at the beginning of tests, and then follows a decreasing trend as the time increases. One of the effects of increasing

Table 3 Average experimental friction coefficients

Lubricant type	Periodic loading		Static loading	
	With OS	Without OS	With OS	Without OS
Base oil	0.089	0.122	0.088	0.117
Base oil +3% additive	0.065	0.095	0.063	0.093
Lubricant 1	0.056	0.105	0.049	0.097
Lubricant 1 +3% additive	0.054	0.086	0.044	0.080
Lubricant 2	0.076	0.106	0.067	0.101
Lubricant 2 +3% additive	0.062	0.091	0.055	0.085

temperature in the test bearing is the decrease in the coefficient of friction since increasing temperature causes a decrease in the lubricant viscosity. The lubricant squeezes out faster from the pores in the bearing to the test journal due to reduced viscosity caused by increasing bearing temperature. Thus, a partially lubricating film

begins forming between the journal and the test bearing. As a result of this, the coefficient of friction shows a decreasing trend in the porous bearing. Table 4 shows the mean temperature rise of the test bearing with and without OS lubricating conditions for all test lubricants. It was found that a low viscosity lubricant (Lubricant 1

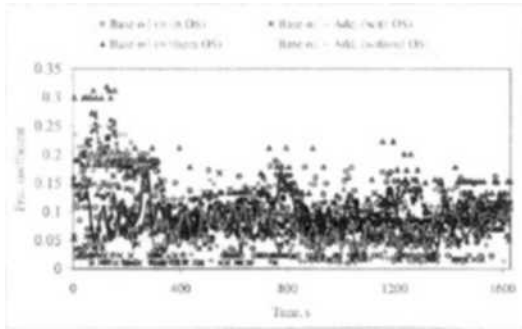

Fig. 6 Coefficient of friction as a function time under periodic loading condition

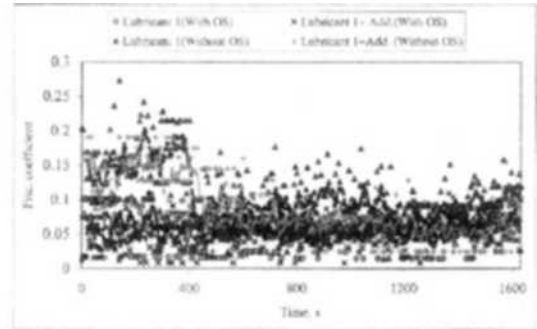

Fig. 7 Coefficient of friction as a function time under periodic loading condition

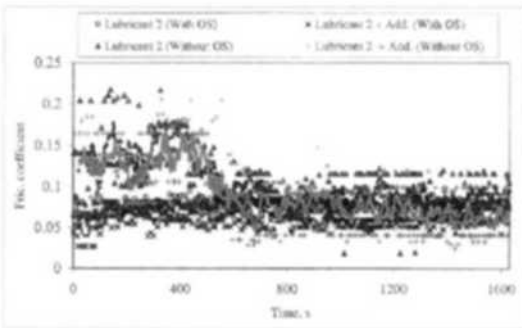

Fig. 8 Coefficient of friction as a function time under periodic loading condition

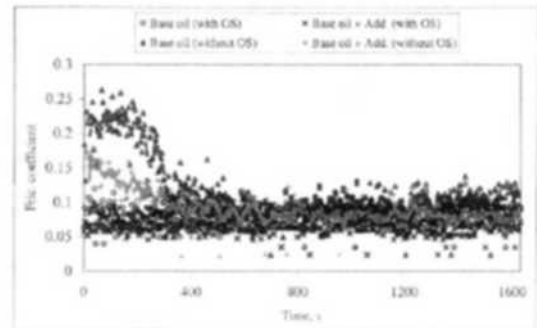

Fig. 9 Coefficient of friction as a function time under static loading condition

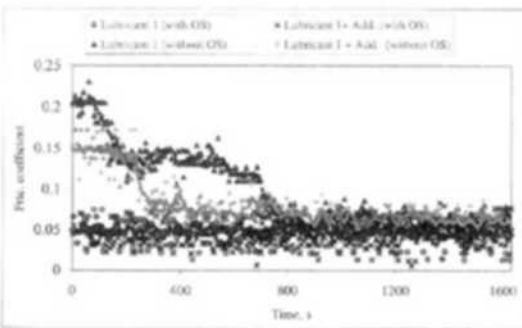

Fig. 10 Coefficient of friction as a function time under static loading condition

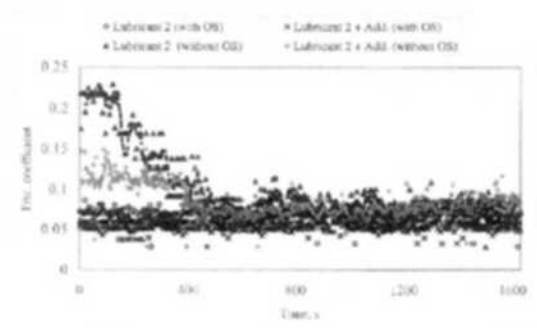

Fig. 11 Coefficient of friction as a function time under static loading condition

and 2) caused the bearings to have lower friction coefficient and lower mean temperature rise than when a high viscosity lubricant (base oil) was used. Also, the bearing temperature rise was lower in the tests with OS due to the cooling effect of lubricant as compared with the tests without OS.

The peaks of surface asperities in the loaded part of the porous bearing will be worn away by the rotating journal. From the curves in the figures (Figures 6-11) it is realized that surfaces are not completely flat and are still undergoing running-in process. When two surfaces come into sliding contact, the friction heating produced at the interface can cause a rapid rise in temperature. The temperature rise may cause surface oxidation, peak deformation and thermomechanical wear (Hornig et al., 2002). Fu et al. showed (Fu et al., 1998) that there was a sudden increase in coefficient of friction at the initial stage and this was attributed to the breakage of the mechanical bonds or local welding between the roughness peaks of the two counterfaces. After that, a constant coefficient of friction was observed. As above mentioned, the coefficient of friction was relatively high at the beginning of the tests but after about 400 seconds (generally in the interval of 300-600 s) the coefficient friction declined rapidly, and then the fluctuating behavior had lesser magnitude until the end of test. In addition, Andersson et al. (1996) assumed that the sliding surfaces tested in a lubricated environmental become polished during running-in. They also observed that the lubrication mechanism was transformed from boundary or mixed lubrication to full film lubrication. Besides, Kaneko (1993), explained that two effects were responsible for oil film formation in the clearance of porous oil bearing; one was oil feed effect known as pumping effect arising from oil film pressure in the clearance and the other was oil seepage from pores to bearing surface by reduced oil viscosity and by increased oil volume due to thermal expansion induced by frictional heat generated at the bearing sliding surface.

If the shaft is undergoing periodic loading, which in practice will often be the case, then the conformity between the shaft and the bearing

will not be achieved because of the alternating shaft position. Mixed lubrication will then occur permanently, resulting in higher friction and wear (Braun, 1982). The applied load was varied from 0 to 200 N (see Figure 5) which was equivalent to average bearing pressure 0 to 0.720 MPa under the periodic loading condition. Since the load is variable, the friction force does not remain stable during the cycle. Lubricant film thickness decreases in the region where the friction force increases as the load gets higher. Therefore, coefficient of friction will naturally show more fluctuating behavior under periodic loading condition compared with static loading condition.

Tests conducted with base oil indicated higher friction coefficients than two fully formulated oils in both lubricating conditions. The results of the test with bearing impregnated with Lubricant-1 indicated both more stable frictional properties and lower average friction coefficient than bearing impregnated with base oil or Lubricant-2. As above mentioned, all test results showed more fluctuation in the coefficient of friction data in the periodic loading condition than under static loading condition.

Lubricant additives are chemicals which, when present in small amounts, improve the physical, chemical or tribological properties of the lubricant (Kaleli and Berthier, 2001). The additives either adsorb onto the sliding surfaces upon contact (friction modifiers) or react with the surfaces under extreme conditions (extreme-pressure, EP, additives), and in both cases form protective layers of low shear modulus, which protect the underlying solid surfaces (McFaden et al., 1997). It is generally accepted that an asperity has three protective films against surface damage during sliding, an oxide film on the substrate, an adsorbed or reactive surface film over oxide, and a lubricant film. During sliding, frictional work is converted into heat, and the heat is transferred to the asperity tips, thus giving rise to asperity flash temperatures, which are much higher than those of the bulk (Yang and Chung, 1997). As understood from the results of the friction tests (see Figures 6-11, and Table 3), lubricating oils containing additive reduced the friction force.

Action mechanism of the additive can be described as follows. During the boundary lubrication regime, new wear particles are being created at the point of asperity contact. At the same time ultrasonic vibrations are created by the shearing forces at the frictional interface between the wear surfaces. The newly created particles are highly activated because of the momentary disturbance of the particle's crystal lattice brought about by the shearing force. Simultaneously, the additive's chemical structure undergoes molecular cleavage through sonochemical influence (ultrasonic energy), which results in the formation of certain organic radicals. Then the additive combines instantaneously with the activated wear particles. This newly formed substance exists only at the point of contact and adheres to the metal surface by chemisorption. The ultrasonic energy emitted at the point of contact triggers the reaction between the additive's radical and the new wear particles. The result is the formation of a new substance that is described as organometallic. These organometallic substances form a mixture which is eutectic (a mixture of materials with the lowest melting point) under the influence of the reaction condition. This ultra-thin eutectic film is created and acts like a solid lubricant that can withstand the load. The eutectic film is also fluidized by frictional heat in the course of mechanical movement. In its fluid state, the eutectic film causes tribological surfaces to hydroplane over each other even under extremely high loading. This eutectic film becomes the new sacrificial film under boundary lubrication conditions and replenishes itself during operation (Technical

Bulletin, 1990).

Adding oil additive to all lubricants showed a reduction in the average coefficient of friction in the tests with and without OS lubricating conditions. This reduction was larger in the base oil than two fully formulated oil for both lubricating conditions. Commercial additive at the ratio of 3% concentration reduced the average coefficient of friction by 26.9%, 3.5%, and 18.4%, for base oil, lubricant-1, and lubricant-2 tests respectively, with OS under periodic loading. Reduction ratio for the tests without OS at the same loading condition was determined as 22.1%, 18.0% and 14.1% for base oil, lubricants 1, and 2 respectively. For static loading condition, reduction ratio was determined as 28.4%, 10.2%, and 17.9% for tests with OS, and as 20.5%, 17.5%, and 15.8% for the tests without OS.

Yong-Xin et al.(1985) concluded that it is important to select the right kind of oil for sintered bearings operating under given conditions. In their study, the lubricant with oily additive decreased friction coefficient and wear, and increased the limiting PV value of sintered

Table 4 The mean temperature rise on the test bearings for all lubricants (°C)

	Without OS	With OS
Base oil	7.6	4.5
Base oil +3% additive	7.1	5
Lubricant 1	5	2.3
Lubricant 1 +3% additive	5.2	2.1
Lubricant 2	5.5	2.6
Lubricant 2 +3% additive	5.6	2.4

Table 5 Experimental wear loss (g)

Lubricant type	Periodic loading		Static loading	
	With OS	Without OS	With OS	Without OS
Base oil	0.0067	0.0092	0.0064	0.0085
Base oil +3% additive	0.0054	0.0078	0.0056	0.0074
Lubricant 1	0.0048	0.0068	0.0043	0.0069
Lubricant 1 +3% additive	0.0040	0.0060	0.0039	0.0057
Lubricant 2	0.0058	0.0080	0.0049	0.0075
Lubricant 2 +3% additive	0.0047	0.0072	0.0043	0.0063

bearing under boundary lubrication.

The wear loss were calculated from differences of specimen weights measured before and after the tests using an electronic balance. The results of wear loss of the test bearings are given in Table 4. According to these results, tests conducted with base oil showed lower wear resistance than two fully formulated oils. Figures 12–14 show that the microstructure of the bearing tested with all lubricants for with and without OS lubricating conditions. Particularly, in the tests without OS larger and deeper wear tracks on the surfaces of bearings were clearly seen in the tests using base oil when compared with two fully formulated oils (lubricant 1 and 2) (see Figures 12–14). It can be seen that the wear mechanism in the sliding direction is abrasive wear. Because the tests without OS had no continuous lubricant flow, the wear debris might remain between the surfaces of the shaft and the journal. Therefore, tracks of abrasive wear could be seen. It is believed that with OS lubrication condition, a layer of lubricating oil film can be more easily formed on the bearing surface, thus the lubrication condition of the frictional surface can be greatly improved, leading to a decrease in wear loss. On

the other hand with OS lubrication condition, both surfaces were easily separated from each other, and the wear debris were removed from surfaces by means of continuous lubricant circulation.

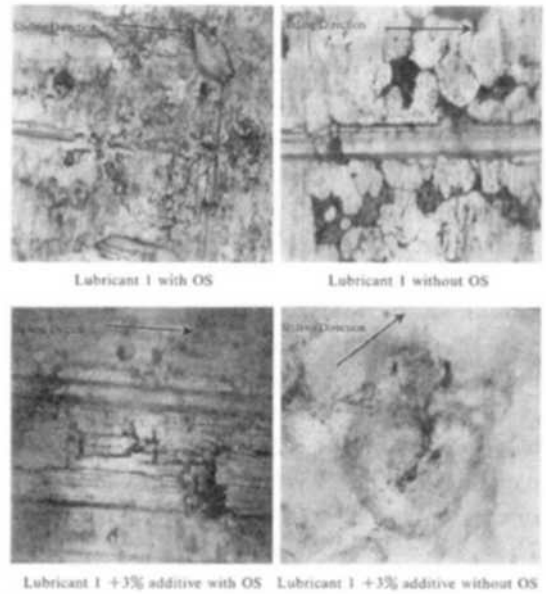

Fig. 13 Optical microscopy of the bearing surface tested with Lubricant 1 (—| 20 μm)

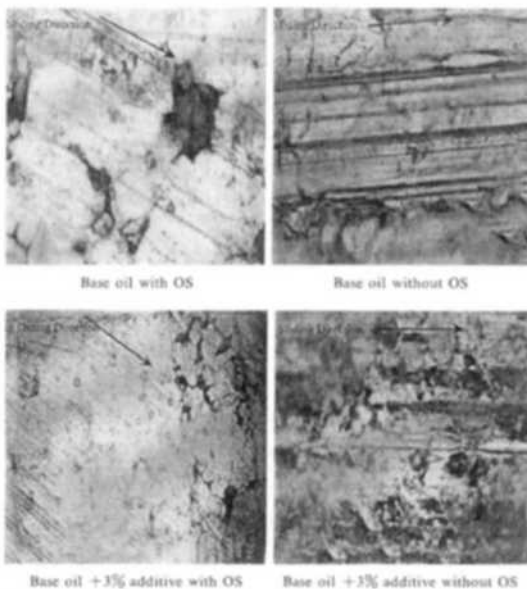

Fig. 12 Optical microscopy of the bearing surface tested with base oil

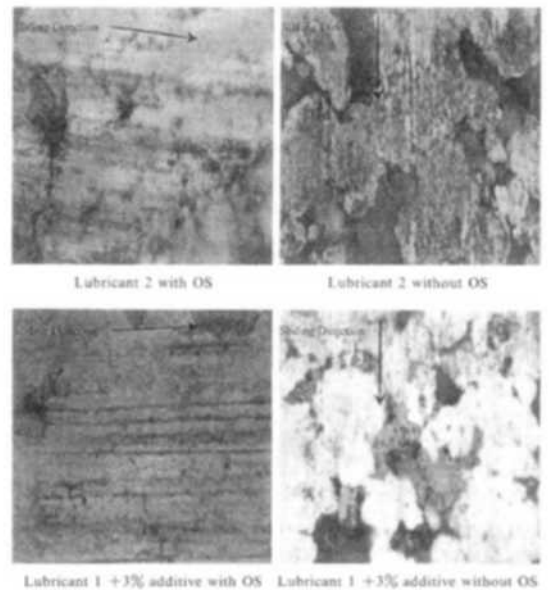

Fig. 14 Optical microscopy of the bearing surface tested with Lubricant 2 (—| 20 μm)

Also, the effect of additive in reducing the wear can be seen in Figure 12. Lubricants-1, -2 and commercial oil additive (3%) added into those oils resulted in smaller wear tracks, and distribution of the smaller wear tracks was more homogenous as shown by the examination using optical microscopy (Figures 13-14.). The smaller coefficients of friction resulted in the tests due to the protective layer formed on the sliding bearing surfaces by fully formulated oils (lubricants 1, and 2) and lubricant additives. Therefore it was found that the coefficient of friction was smaller during the lower wear loss sliding condition (Table 4).

The results showed that wear loss decreases by adding oil additive in the lubricating conditions for both tests with and without OS. From Table 4, it can be seen that the weight loss is greatly reduced under tests with OS lubricating condition for both loading conditions. Fu et al. (1998) expressed that, this is due to the formation of a coherent oil film between the surfaces of the journal and the bearing, which prevents actual contact between the two surfaces. As a result, the adhesion, plastic and shear deformation of the asperities are significantly reduced, leading to a decrease in the material removed. Another possible reason is the removal of the wear debris, metal chips, dirt and contaminants from the surfaces by the flowing lubricant thereby reducing the amount of third-body abrasive friction and wear under tests with OS.

4. Conclusions

In this study, a new test rig was designed to measure the tribological properties of porous bearings manufactured with P/M under both static and dynamic loadings. Base oil (SAE 20W50), two fully formulated commercial engine oil (SAE20W50) and lubricating oil with commercial additive concentration ratio of 3% were used in the tests. Also, tests were conducted to determine the effects of lubricating conditions with and without OS on the tribological properties of porous bearing.

(1) The results of the tests showed that the

change in friction coefficient is more stable and in smaller values under static loading compared with periodic loading.

(2) The results of the tests indicated that two fully formulated oils have better friction and wear properties than base oil with and without OS.

(3) To improve the tribological properties of porous bearing, particularly for without OS lubricating condition, more effective additives should be used in the boundary lubrication regime.

(4) The experimental results obtained in this study indicated that the correct selection of lubricant and suitable running conditions are very important on the tribological properties of porous bearings.

References

- Andersson, P., Juhanko, J., Nikkila, A. P. and Lintula, P., 1996, "Influence of Topography on the Running-in of Water-lubricated Silicon Carbide Journal Bearings," *Wear*, Vol. 201, pp. 1~9.
- Braun, A. L., 1982, "Porous Bearings," *Tribology International*, Vol. 15, pp. 235~242.
- Cusano, C. and Phelan, R. M., 1973, "Experimental Investigation of Porous Bronze Bearings," *Trans. ASME, Journal of Lubrication Technology*, Vol. 95, pp. 173~180.
- Cusano, C., 1997, "Porous Metal Bearings," in: *Tribology Data Handbook*, E. R. Booser (Ed.), CRC Press, New York, pp. 719~734.
- Durak, E., Kurbanoglu, C., Kaleli, H. and Tunay, R. F., 2002, "Measurement of Friction Force and Wear of Base Sintered Journal Bearings Manufactured With Powder Metallurgy (P/M)," in: *4th International Conference on Tribology*, pp. 399--405, Kayseri-Turkey.
- Fu, Y., Batchelor, A. W., Loh, N. L. and Tan, K. W., 1998, "Effect of Lubrication by Mineral and Synthetic Oils on the Sliding Wear of Plasma Nitrided AISI 410 Stainless Steel," *Wear*, Vol. 219, pp. 169~176.
- Horng, J. H., Len, M. L. and Lee, J. S., 2002, "The Contact Characteristics of rough Surfaces in Line Contact During Running-in Process," *Wear*, Vol. 253, pp. 899~913.

- Junghans, R., Neukirchner, J., Schumann, D. and Lippman, K. H., 1996, "The Use of Sintered Metal Bearings for High Sliding Velocities," *Tribology International*, Vol. 29, No. 3, pp. 181~192.
- Kaleli, H. and Berthier, Y., 2001, "The Mechanism of Layer Formation and the Function of Additives Used in Fully Formulated Engine Crankcase Oils, Boundary and Mixed Lubrication: Science and Applications," *Proceedings of the 28th Leeds-Lyon Symposium on Tribology as a part World Tribology Congress*, WTC, in Vienna, in press.
- Kaneko, S., 1993, "Porous Oil Bearings," *Japanese Journal of Tribology*, Vol. 38, No. 9, pp. 1141~150.
- Kasahara, M., 1997, "Recent Development of Oilless Bearings," *Japanese Journal of Tribology*, Vol. 42, No. 4, pp. 425~433.
- Kurbanoglu, C., Durak, E., Tunay, R. F. and Tüfekci, K., 2002, "Experimental Investigations of Porous Bearing Under Dynamical Loading," in. *Proc. 3rd International Powder Metallurgy Conference*, Ankara-Turkey, "In Turkish, in Press.
- McFadden, C., Soto, C. and Spencer, N. D., 1997, "Adsorption and Surface Chemistry in Tribology," *Tribology International*, Vol. 30-12, pp. 881~888.
- Raman, R. and Chennabasavan, T. S., 1998, "Experimental Investigations of Porous Bearings Under Vertical Sinusoidally Fluctuating Loads," *Tribology International*, Vol. 31, No. 6, pp. 325~330.
- Technical Bulletin #1, and 2, 1990, *Lubrication Solution and Product Catalogue*, Power up Inc., Canada.
- Yang, Z. and Chung, Y. W., 1997, "Surface Science Perspective of Tribological Failure," *Tribology Letters*, Vol. 3, pp. 19~26.
- Yong-Xin, Q., Ji, M., Yi-Geng, T., Gui-Ru, Z., Gao-Yi, S. and Guo-Liang, W., 1985, "Investigation of Sintered Bronze Bearings Under High-Speed Conditions," *Tribology International*, Vol. 18, No. 2, pp. 75~80.